

## DESCRIPTION

The Galleon™ LED luminaire delivers exceptional performance in a highly scalable, low-profile design. Patented, high-efficiency AccuLED Optics™ system provides uniform and energy conscious illumination to walkways, parking lots, roadways, building areas and security lighting applications. IP66 rated and UL/cUL Listed for wet locations.

Catalog #	GLEON AE 02 LED E1-T4W	Type	B
Project	CLEARCREEK STORAGE	Date	
Comments	20' SSS (1) HEAD		
Prepared by	Geoff Fisher P&B Electric LLC		7-28-20

## SPECIFICATION FEATURES

### Construction

Extruded aluminum driver enclosure thermally isolated from Light Squares for optimal thermal performance. Heavy-wall, die-cast aluminum end caps enclose housing and die-cast aluminum heat sinks. A unique, patent pending interlocking housing and heat sink provides scalability with superior structural rigidity. 3G vibration tested and rated. Optional tool-less hardware available for ease of entry into electrical chamber. Housing is IP66 rated.

### Optics

Patented, high-efficiency injection-molded AccuLED Optics technology. Optics are precisely designed to shape the distribution maximizing efficiency and application spacing. AccuLED Optics create consistent distributions with the scalability to meet customized application requirements. Offered standard in 4000K (+/- 275K) CCT 70 CRI. Optional 3000K, 5000K and 6000K CCT.

### Electrical

LED drivers are mounted to removable tray assembly for ease of maintenance. 120-277V 50/60Hz, 347V 60Hz or 480V 60Hz operation. 480V is compatible for use with 480V Wye systems only. Standard with 0-10V dimming. Shipped standard with Eaton proprietary circuit module designed to withstand 10kV of transient line surge. The Galleon LED luminaire is suitable for operation in -40°C to 40°C ambient environments. For applications with ambient temperatures exceeding 40°C, specify the HA (High Ambient) option. Light Squares are IP66 rated. Greater than 90% lumen maintenance expected at 60,000 hours. Available in standard 1A drive current and optional 600mA, 800mA and 1200mA drive currents (nominal).

### Mounting

**STANDARD ARM MOUNT:** Extruded aluminum arm includes internal bolt guides allowing for easy positioning of fixture during mounting. When mounting two or more luminaires at 90° and 120° apart, the EA extended arm may be required. Refer to the

arm mounting requirement table. Round pole adapter included. For wall mounting, specify wall mount bracket option. **QUICK MOUNT ARM:** Adapter is bolted directly to the pole. Quick mount arm slide into place on the adapter and is secured via two screws, facilitating quick and easy installation. The versatile, patent pending, quick mount arm accommodates multiple drill patterns ranging from 1-1/2" to 4-7/8". Removal of the door on the quick mount arm enables wiring of the fixture without having to access the driver compartment. A knock-out enables round pole mounting.

### Finish

Housing finished in super durable TGIC polyester powder coat paint, 2.5 mil nominal thickness for superior protection against fade and wear. Heat sink is powder coated black. Standard housing colors include black, bronze, grey, white, dark platinum and graphite metallic. RAL and custom color matches available.

### Warranty

Five-year warranty.



## GLEON GALLEON LED

1-10 Light Squares  
Solid State LED

AREA/SITE LUMINAIRE



RECEIVED

AUG 17 2020

CLEARCREEK TO WINSHIP ZONING DEPT. WaveLinX



### CERTIFICATION DATA

3G Vibration Rated  
DesignLights Consortium® Qualified\*  
Dark Sky Approved (3000K CCT and warmer only)  
IP66 Rated  
ISO 9001  
LM79 / LM80 Compliant  
UL/cUL Wet Location Listed

### ENERGY DATA

Electronic LED Driver  
>0.9 Power Factor  
<20% Total Harmonic Distortion  
120V-277V 50/60Hz  
347V, 480V 60Hz  
-40°C Min. Temperature  
40°C Max. Temperature  
50°C Max. Temperature (HA Option)

## DIMENSIONS

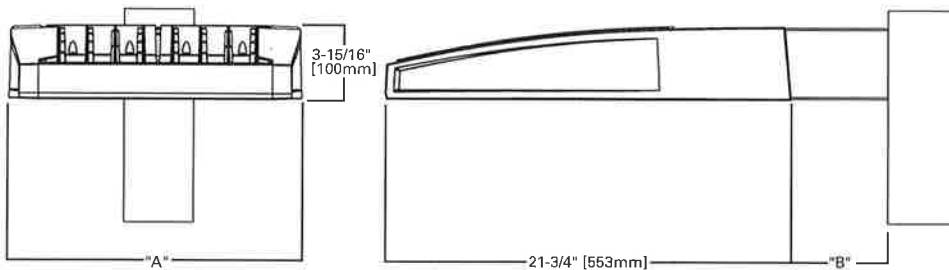

### DIMENSION DATA

Number of Light Squares	"A" Width	"B" Standard Arm Length	"B" Optional Arm Length <sup>1</sup>	Weight with Arm (lbs.)	EPA with Arm <sup>2</sup> (Sq. Ft.)
1-4	15-1/2" (394mm)	7" (178mm)	10" (254mm)	33 (15.0 kgs.)	0.96
5-6	21-5/8" (549mm)	7" (178mm)	10" (254mm)	44 (20.0 kgs.)	1.00
7-8	27-5/8" (702mm)	7" (178mm)	13" (330mm)	54 (24.5 kgs.)	1.07
9-10	33-3/4" (857mm)	7" (178mm)	16" (406mm)	63 (28.6 kgs.)	1.12

NOTES: 1. Optional arm length to be used when mounting two fixtures at 90° on a single pole. 2. EPA calculated with optional arm length.

### DRILLING PATTERN

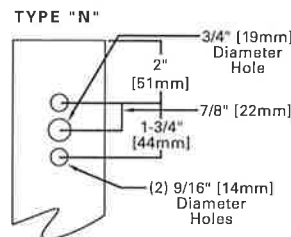

**ARM MOUNTING REQUIREMENTS**

Configuration	90° Apart	120° Apart
GLEON-AF-01	7" Arm (Standard)	7" Arm (Standard)
GLEON-AF-02	7" Arm (Standard)	7" Arm (Standard)
GLEON-AF-03	7" Arm (Standard)	7" Arm (Standard)
GLEON-AF-04	7" Arm (Standard)	7" Arm (Standard)
GLEON-AF-05	10" Extended Arm (Required)	7" Arm (Standard)
GLEON-AF-06	10" Extended Arm (Required)	7" Arm (Standard)
GLEON-AF-07	13" Extended Arm (Required)	13" Extended Arm (Required)
GLEON-AF-08	13" Extended Arm (Required)	13" Extended Arm (Required)
GLEON-AF-09	16" Extended Arm (Required)	16" Extended Arm (Required)
GLEON-AF-10	16" Extended Arm (Required)	16" Extended Arm (Required)

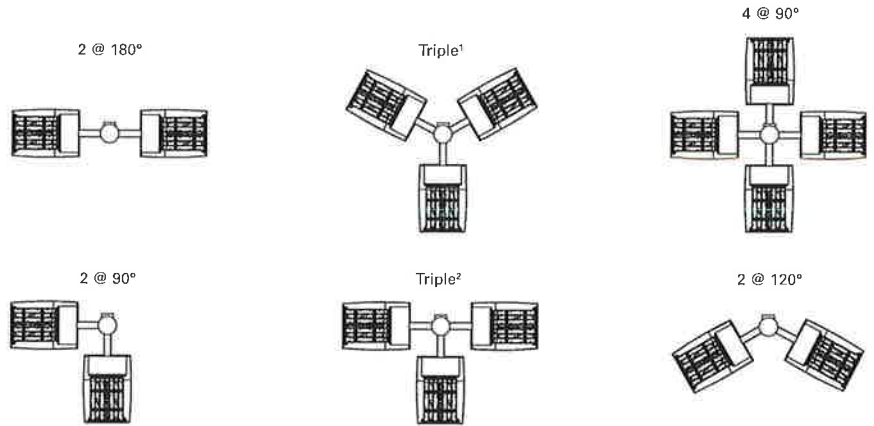

NOTES: 1 Round poles are 3 @ 120°. Square poles are 3 @ 90°. 2 Round poles are 3 @ 90°.

**STANDARD WALL MOUNT**

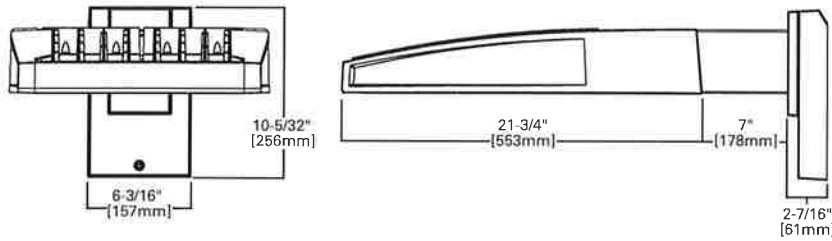

**MAST ARM MOUNT**

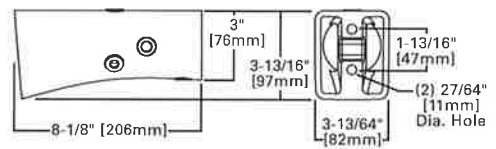

**QUICK MOUNT ARM (INCLUDES FIXTURE ADAPTER)**

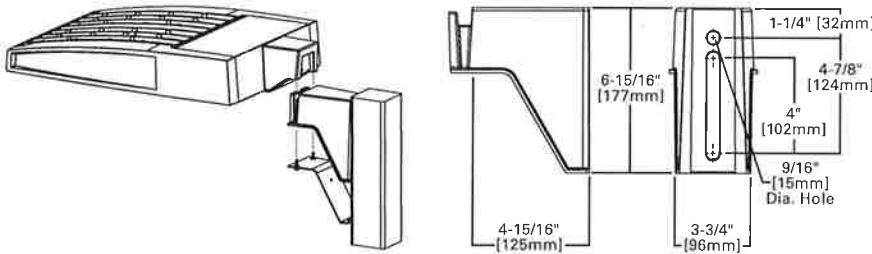

**RECEIVED**  
**AUG 17 2020**  
**CLEARCREEK TOWNSHIP ZONING DEPT.**

**QM Quick Mount Arm (Standard)**

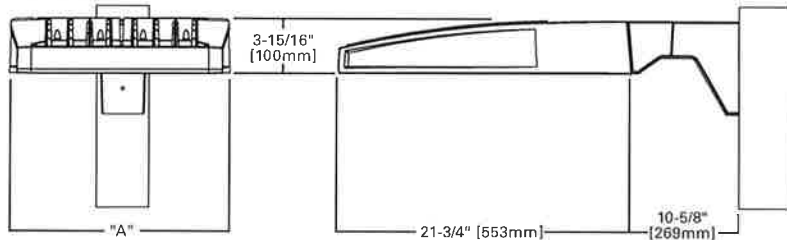

**QMEA Quick Mount Arm (Extended)**

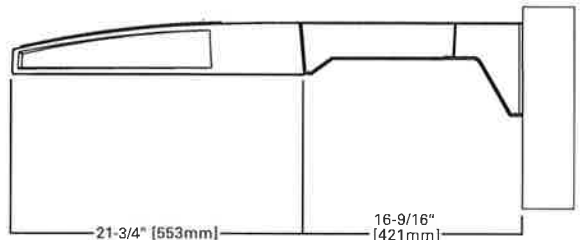

**QUICK MOUNT ARM DATA**

Number of Light Squares <sup>1,2</sup>	"A" Width	Weight with QM Arm (lbs.)	Weight with QMEA Arm (lbs.)	EPA (Sq. Ft.)
1-4	15-1/2" (394mm)	35 (15.91 kgs.)	38 (17.27 kgs.)	1.11
5-6 <sup>3</sup>	21-5/8" (549mm)	46 (20.91 kgs.)	49 (22.27 kgs.)	
7-8	27-5/8" (702mm)	56 (25.45 kgs.)	N/A	

NOTES: 1 QM option available with 1-8 light square configurations. 2 QMEA option available with 1-6 light square configurations. 3 QMEA arm to be used when mounting two fixtures at 90° on a single pole.

**OPTIC ORIENTATION**

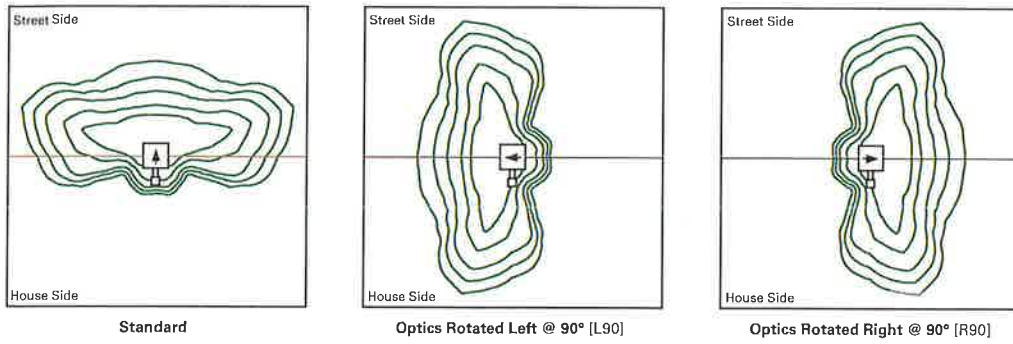

**OPTICAL DISTRIBUTIONS**

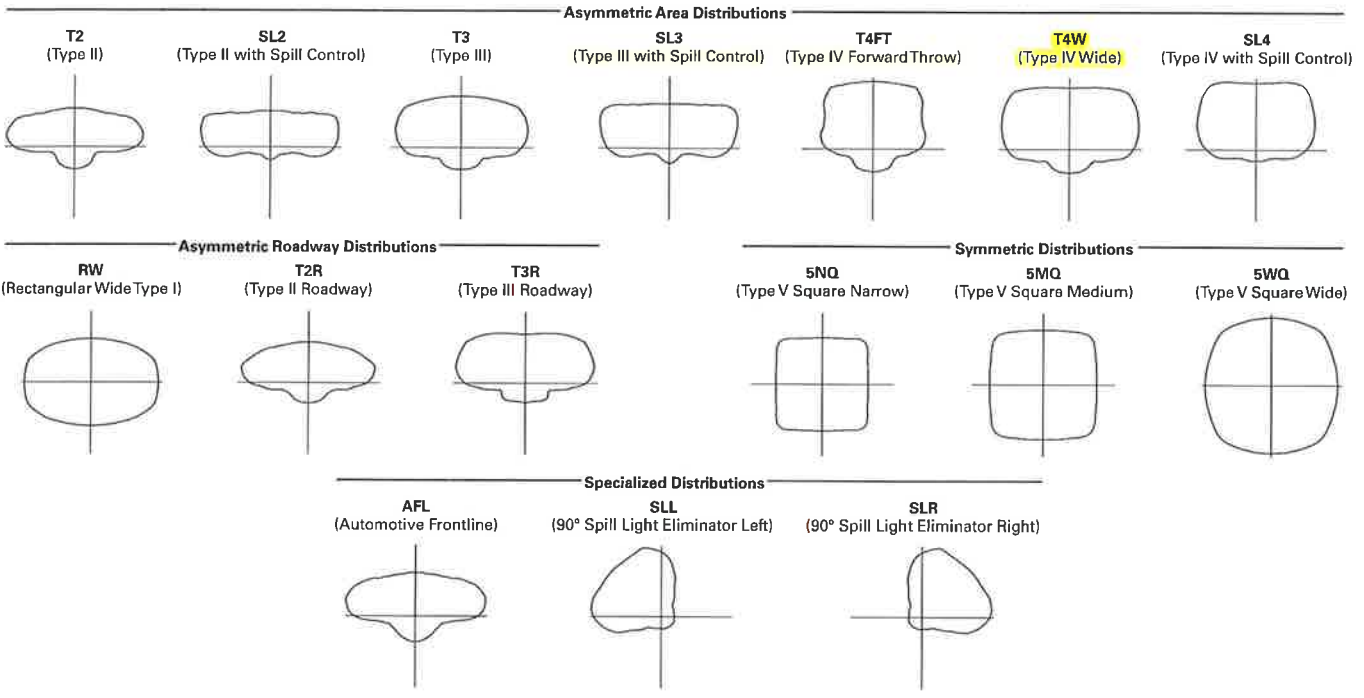

**LUMEN MAINTENANCE**

Drive Current	Ambient Temperature	TM-21 Lumen Maintenance (60,000 Hours)	Projected L70 (Hours)
Up to 1A	Up to 50°C	> 95%	416,000
1.2A	Up to 40°C	> 90%	205,000

**LUMEN MULTIPLIER**

Ambient Temperature	Lumen Multiplier
0°C	1.02
10°C	1.01
25°C	1.00
40°C	0.99
50°C	0.97

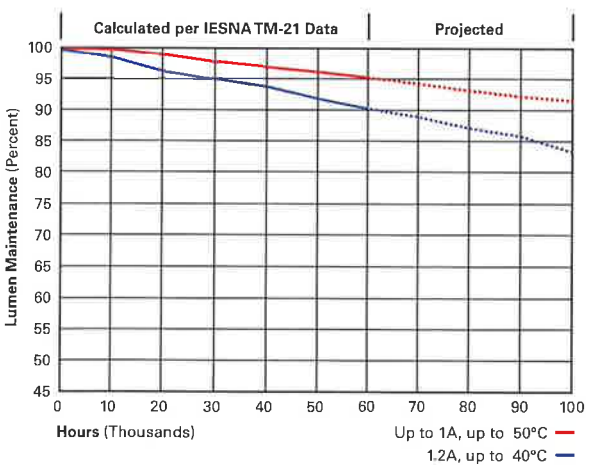

**RECEIVED**  
**AUG 17 2020**  
**CLEARCREEK TOWNSHIP ZONING DEPT.**

ORDERING INFORMATION

Sample Number: GLEON-AF-04-LED-E1-T3-GM-QM

Product Family 1,2	Light Engine	Number of Light Squares 3	Lamp Type	Voltage	Distribution	Color	Mounting			
GLEON=Galleon	AF=1A Drive Current	01=1 02=2 03=3 04=4 05=5 4 06=6 07=7 5 08=8 5 09=9 6 10=10 6	LED=Solid State Light Emitting Diodes	E1=120-277V 347=347V 7 480=480V 13	T2=Type II T2R=Type II Roadway T3=Type III T3R=Type III Roadway T4FT=Type IV Forward Throw T4W=Type IV Wide 5NQ=Type V Narrow 5MQ=Type V Square Medium 5WQ=Type V Square Wide SL2=Type II w/Spill Control SL3=Type III w/Spill Control SL4=Type IV w/Spill Control SLL=90° Spill Light Eliminator Left SLR=90° Spill Light Eliminator Right RW=Rectangular Wide Type I AFL=Automotive Frontline	AP=Grey BZ=Bronze BK=Black DP=Dark Platinum GM=Graphite Metallic WH=White	[Blank]=Arm for Round or Square Pole EA=Extended Arm 3 MA=Mast Arm Adapter 10 WM=Wall Mount QM=Quick Mount Arm (Standard Length) 11 QMEA=Quick Mount Arm (Extended Length) 12			
Options (Add as Suffix)					Accessories (Order Separately)					
7027=70 CRI 2700K 19 7030=70 CRI 3000K 19 8030=80 CRI 3000K 19 7050=70 CRI 5000K 19 7060=70 CRI 6000K 19 600=Drive Current Set to Nominal 600mA 15 800=Drive Current Set to Nominal 800mA 15 1200=Drive Current Set to Nominal 1200mA 15,16 F=Single Fuse (120, 277 or 347V. Specify Voltage) FF=Double Fuse (208, 240 or 480V. Specify Voltage) 2L=Two Circuits 17,18 DIM=External 0-10V Dimming Leads 19,20 DIM10=Synapse Integrated Control Module 14,19 AHD145=After Hours Dim, 5 Hours 22 AHD245=After Hours Dim, 6 Hours 22 AHD255=After Hours Dim, 7 Hours 22 AHD355=After Hours Dim, 8 Hours 22 HA=50°C High Ambient 23 L90=Optics Rotated 90° Left R90=Optics Rotated 90° Right MT=Installed Mesh Top TH=Tool-less Door Hardware HSS=Installed House Side Shield 29 CE=CE Marking 29 LCF=Light Square Trim Painted to Match Housing 27					P=Button Type Photocontrol (120, 208, 240 or 277V. Must Specify Voltage) 21 PER7=NEMA 7-PIN Photocontrol Receptacle 21 R=NEMA Photocontrol Receptacle 21 MS-L08=Motion Sensor for ON/OFF Operation, Maximum 8' Mounting Height 24 MS-L20=Motion Sensor for ON/OFF Operation, 9' - 20' Mounting Height 24 MS-L40W=Motion Sensor for ON/OFF Operation, 21' - 40' Mounting Height 24 MS/DIM-L08=Motion Sensor for Dimming Operation, Maximum 8' Mounting Height 24 MS/DIM-L20=Motion Sensor for Dimming Operation, 9' - 20' Mounting Height 24 MS/DIM-L40W=Motion Sensor for Dimming Operation, 21' - 40' Mounting Height 24 MS/X-L08=Bi-Level Motion Sensor, Maximum 8' Mounting Height 24,25 MS/X-L20=Bi-Level Motion Sensor, 9' - 20' Mounting Height 24,25 MS/X-L40W=Bi-Level Motion Sensor, 21' - 40' Mounting Height 24,25 LWR-LW=LumaWatt Pro Wireless Sensor, Wide Lens for 8' - 16' Mounting Height 28 LWR-LN=LumaWatt Pro Wireless Sensor, Narrow Lens for 16' - 40' Mounting Height 28 ZW=WaveLinX-enabled 4-PIN Twistlock Receptacle 19,33 ZW-SWPD4XX=WaveLinX Wireless Sensor, 7' - 15' Mounting Height 19,33,34 ZW-SWPD5XX=WaveLinX Wireless Sensor, 15' - 40' Mounting Height 19,33,34			OA/RA1016=NEMA Photocontrol Multi-Tap - 105-285V OA/RA1027=NEMA Photocontrol - 480V OA/RA1201=NEMA Photocontrol - 347V OA/RA1013=Photocontrol Shorting Cap OA/RA1014=120V Photocontrol MA1252=10kV Surge Module Replacement MA1036-XX=Single Tenon Adapter for 2-3/8" O.D. Tenon MA1037-XX=2@180° Tenon Adapter for 2-3/8" O.D. Tenon MA1197-XX=3@120° Tenon Adapter for 2-3/8" O.D. Tenon MA1188-XX=4@90° Tenon Adapter for 2-3/8" O.D. Tenon MA1189-XX=2@90° Tenon Adapter for 2-3/8" O.D. Tenon MA1190-XX=3@90° Tenon Adapter for 2-3/8" O.D. Tenon MA1191-XX=2@120° Tenon Adapter for 2-3/8" O.D. Tenon MA1038-XX=Single Tenon Adapter for 3-1/2" O.D. Tenon MA1039-XX=2@180° Tenon Adapter for 3-1/2" O.D. Tenon MA1192-XX=3@120° Tenon Adapter for 3-1/2" O.D. Tenon MA1193-XX=4@90° Tenon Adapter for 3-1/2" O.D. Tenon MA1194-XX=2@90° Tenon Adapter for 3-1/2" O.D. Tenon MA1195-XX=3@90° Tenon Adapter for 3-1/2" O.D. Tenon FSIR-100=Wireless Configuration Tool for Occupancy Sensor 24 GLEON-MT1=Field Installed Mesh Top for 1-4 Light Squares GLEON-MT2=Field Installed Mesh Top for 5-6 Light Squares GLEON-MT3=Field Installed Mesh Top for 7-8 Light Squares GLEON-MT4=Field Installed Mesh Top for 9-10 Light Squares GLEON-QM=Quick Mount Arm Kit 11 GLEON-QMEA=Quick Mount Extended Arm Kit 12 LS/HSS=Field Installed House Side Shield 28,30 WOLC-7P-10A=WaveLinX Outdoor Control Module 19,31 SWPD4-XX=WaveLinX Wireless Sensor, 7' - 15' Mounting Height 19,32,33,34 SWPD5-XX=WaveLinX Wireless Sensor, 15' - 40' Mounting Height 19,32,33,34		

NOTES:

1 Customer is responsible for engineering analysis to confirm pole and fixture compatibility for all applications. Refer to our white paper WP513001EN for additional support information. 2 DesignLights Consortium® Qualified. Refer to www.designlights.org Qualified Products List under Family Models for details. 3 Standard 4000K CCT and minimum 70 CRI. 4 Not compatible with MS/4-LXX or MS/1-LXX sensors. 5 Not compatible with extended quick mount arm (QMEA). 6 Not compatible with standard quick mount arm (QM) or extended quick mount arm (QMEA). 7 Requires the use of an internal step down transformer when combined with sensor options. Not available with sensor at 1200mA. Not available in combination with the HA high ambient and sensor options at 1A. 8 Only for use with 480V Wye systems. Per NEC, not for use with ungrounded systems. Impedance grounded systems or corner grounded systems (commonly known as Three Phase Three Wire Delta, Three Phase High Leg Delta and Three Phase Corner Grounded Delta systems). 9 May be required when two or more luminaires are oriented on a 90° or 120° drilling pattern. Refer to arm mounting requirement table. 10 Factory installed. 11 Maximum 8 light squares. 12 Maximum 6 light squares. 13 Extended lead times apply. Use dedicated IES files for 2700K, 3000K, 5000K and 6000K when performing layouts. 14 Available in 800mA only. 15 1 Amp standard. Use dedicated IES files for 600mA, 800mA and 1200mA when performing layouts. 16 Not available with HA option. 17 2L is not available with MS, MS/X or MS/DIM at 347V or 480V. 2L in AF-02 through AF-04 requires a larger housing, normally used for AF-05 or AF-06. Extended arm option may be required when mounting two or more fixtures per pole at 90° or 120°. Refer to arm mounting requirement table. 18 Not available with LumaWatt Pro wireless sensors. 19 Cannot be used with other control options. 20 Low voltage control lead brought out 18" outside fixture. 21 Not available if any "MS" sensor is selected. Motion sensor has an integral photocell. 22 Requires the use of P photocontrol or the PER7 or R photocontrol receptacle with photocontrol accessory. See After Hours Dim supplemental guide for additional information. 23 60°C lumen maintenance data applies to 600mA, 800mA and 1A drive currents. 24 The FSIR-100 configuration tool is required to adjust parameters including high and low modes, sensitivity, time delay, cutoff and more. Consult your lighting representative at Eaton for more information. 25 Replace X with number of Light Squares operating in low output mode. 26 LumaWatt Pro wireless sensors are factory installed only requiring network components LWP-EM-1, LWP-GW-1 and LWP-PoE8 in appropriate quantities. See www.eaton.com/lighting for LumaWatt Pro application information. 27 Not available with house side shield (HSS). 28 Only for use with SL2, SL3, SL4 and AFL distributions. The Light Square trim plate is painted black when the HSS option is selected. 29 CE is not available with the LWR, MS, MS/X, MS/DIM, P, R or PER7 options. Available in 120-277V only. 30 One required for each Light Square. 31 Requires PER7. 32 Requires ZW. 33 WAC Gateway required to enable field-configurability: Order WAC-PoE and WPOE-120 (10V to PoE injector) power supply if needed. 34 Replace XX with sensor color (WH, BZ, or BK).

LumenSafe Integrated Network Security Camera Technology Options (Add as Suffix)

Product Family	Camera Type	Data Backhaul	
L=LumenSafe Technology* 	D=Dome Camera, Standard H=Dome Camera, Hi-Res Z=Dome Camera, Remote PTZ	C=Cellular, Customer Installed SIM Card A=Cellular, Factory Installed AT&T SIM Card V=Cellular, Factory Installed Verizon SIM Card S=Cellular, Factory Installed Sprint SIM Card	W=Wi-Fi Networking w/ Omni-Directional Antenna E=Ethernet Networking

\*Consult LumenSafe system pages for additional details and compatibility.

**RECEIVED**  
**AUG 17 2020**  
**CLEARCREEK TOWNSHIP**  
**ZONING DEPT.**



Catalog Number	OLLWUP14000K120
Notes	MOUNT 12' AFG
Type	CC

## FEATURES & SPECIFICATIONS

### INTENDED USE

Provides years of maintenance-free illumination for outdoor use in residential & commercial applications. Ideal for applications such as lighting walkways and stairways for safety and security.

### CONSTRUCTION

Cast-aluminum housing with corrosion-resistant paint in either dark bronze or white finish.

ADA compliant.

### OPTICS

4000K CCT LEDs.

Polycarbonate lens protects the LED from moisture, dirt and other contaminants.

**LUMEN MAINTENANCE:** The LED will deliver 70% of its initial lumens at 50,000 hour average LED life. See Lighting Facts label on page 2 for performance details.

### ELECTRICAL

MVOLT driver operates on any line voltage from 120-277V

Operating temperature -30°C to 40°C.

1KV surge protection standard.

### INSTALLATION

Surface mounts to universal junction box (provided by others).

### LISTINGS

UL Listed to U.S. and Canadian safety standards for wet locations.

Tested in accordance with IESNA LM-79 and LM-80 standards.

**WARRANTY** — 5-year limited warranty. Complete warranty terms located at:

[www.acuitybrands.com/support/kustomec-support/terms-and-conditions](http://www.acuitybrands.com/support/kustomec-support/terms-and-conditions)

**Note:** Actual performance may differ as a result of end-user environment and application.

All values are design or typical values, measured under laboratory conditions at 25 °C.

Specifications subject to change without notice.

Outdoor General Purpose

# OLLWD & OLLWU

LED WALL CYLINDER LIGHT



### Specifications

All dimensions are inches (centimeters)

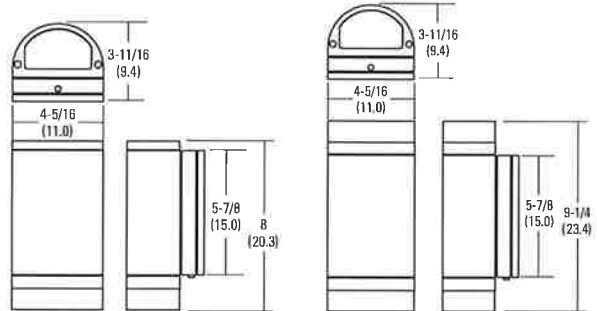

### ORDERING INFORMATION

For shortest lead times, configure products using **bolded options**.

**Example:** OLLWD LED P1 40K MVOLT DDB

Series	Performance Package	Color temperature (CCT)	Voltage	Finish
<b>OLLWD LED</b> Downlight	<b>P1</b>	<b>40K</b> 4000K	<b>MVOLT</b> 120V-277V	<b>DDB</b> Dark bronze
<b>OLLWU LED</b> Up & downlight			<b>120</b> 120V <sup>1</sup>	<b>WH</b> White <sup>2</sup>

RECEIVED

AUG 17 2020

CLEARCREEK TOWNSHIP  
ZONING DEPT.

### Notes

1. Only available with OLLWU and in DDB.
2. Only available with OLLWU.

# OLLWD & OLLWU LED Wall Cylinder Light

## PHOTOMETRICS

To see complete photometric reports or download .ies files for this product, visit Lithonia Lighting's Outdoor LED homepage  
Tested in accordance with IESNA LM-79 and LM-80 standards.

### OLLWD

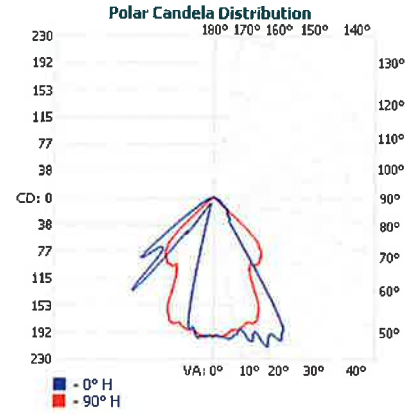
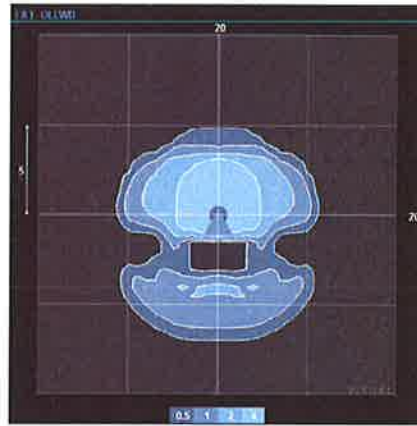
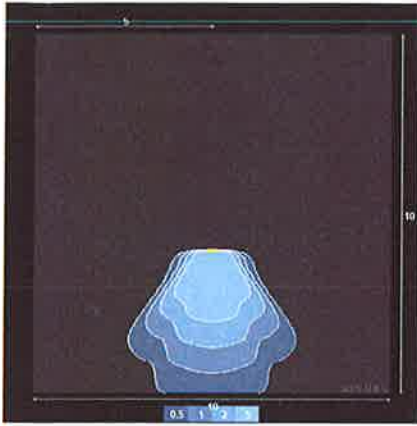

### OLLWU

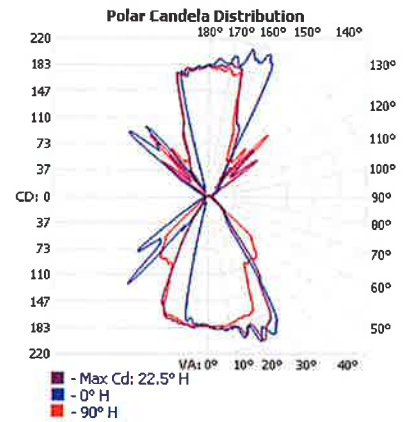
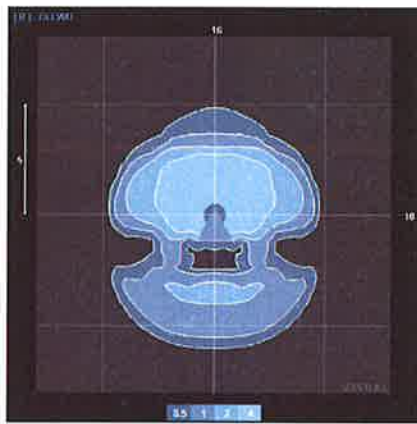

### OLLWD

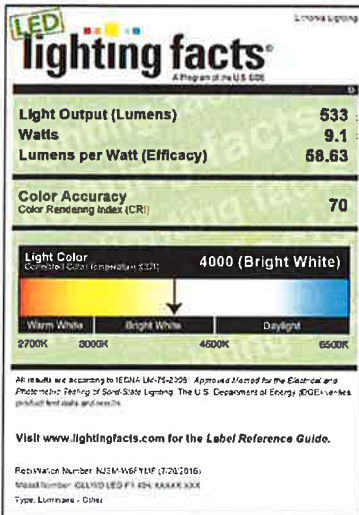

### OLLWU

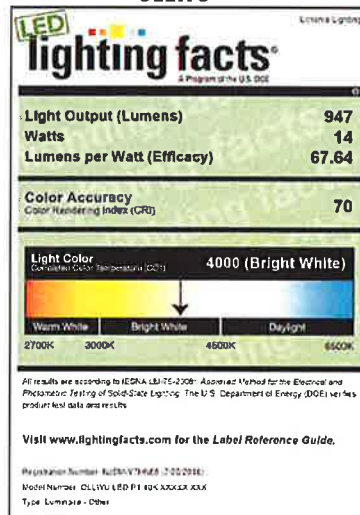

RECEIVED

AUG 17 2020

CLEARCREEK TOWNSHIP  
ZONING DEPT.

# Steel Poles



## SSS SQUARE STRAIGHT STEEL

Catalog #	SSS4A20SFA1X (1) HEAD	Type	C
Project	CLEARCREEK STORAGE	Date	
Comments	20' poles 1	Prepared by	7-28-20
Prepared by	Geoffrey E. Fisher		

### FEATURES

- ASTM Grade steel base plate with ASTM A366 base cover
- Hand hole assembly 3" x 5" on 5" and 6" pole; and 2" x 4" on 4" pole
- 10'-39' mounting heights
- Drilled or tenon (specify)

### DESIGN CONSIDERATIONS

Wind induced vibrations resulting from steady, unidirectional winds and other aerodynamic forces, as well as vibration and coefficient of height factors for non-grounded mounted installations (e.g., installations on bridges or buildings) are not included in this document. The information contained herein is for general guidance only and is not a replacement for professional judgement. Consult with a professional, and local and federal standards, before ordering to ensure product is appropriate for the intended purpose and installation location. Also, please review Eaton's Light Pole White Paper for risk factors and design considerations, [Learn more](#).

Specifications and dimensions subject to change without notice. Consult your lighting representative at Eaton or visit [www.eaton.com/lighting](http://www.eaton.com/lighting) for available options, accessories and ordering information.

### ORDERING INFORMATION

SAMPLE NUMBER: SSA5A20SFM1XG

Product Family	Shaft Size (Inches) <sup>1</sup>	Wall Thickness (Inches)	Mounting Height (Feet)	Base Type	Finish	Mounting Type	Number and Location of Arms	Arm Lengths (Feet)	Options (Add as Suffix)
SSS=Square Straight Steel	4=4" 5=5" 6=6"	A=0.120" M=0.188" X=0.250"	10=10' 15=15' 20=20' 25=25' 30=30' 35=35' 39=39'	S=Square Steel Base	F=Dark Bronze G=Galvanized Steel J=Summit White K=Carbon Bronze L=Dark Platinum R=Hartford Green S=Silver T=Graphite Metallic V=Grey W=White X=Custom Color Y=Black	2=2-3/8" O.D. Tenon (4" Long) 3=3-1/2" O.D. Tenon (5" Long) 4=4" O.D. Tenon (6" Long) 9=3" O.D. Tenon (4" Long) 6=2-3/8" O.D. Tenon (6" Long) 7=4" O.D. Tenon (10" Long) A=Type A Drilling C=Type C Drilling E=Type E Drilling F=Type F Drilling G=Type G Drilling J=Type J Drilling K=Type K Drilling M=Type M Drilling N=Type N Drilling R=Type R Drilling S=Standard Upsweep Arm Z=Type Z Drilling	1=Single 2=2 at 180° 3=Tripto 4=4 at 90° 5=2 at 90° X=None	X=None 2=2' 3=2.5' 4=4' 6=6' 8=8'	A=1/2" Tapped Hub <sup>3</sup> B=3/4" Tapped Hub <sup>3</sup> C=Convenience Outlet <sup>4</sup> E=GFCI Convenience Outlet <sup>4</sup> G=Ground Lug H=Additional Hand Hole <sup>5</sup> V=Vibration Damper

NOTES: 1. All shaft sizes nominal. 2. Square poles are 3 at 90°, round poles are 3 at 120°. 3. Tapped Hub is located 5' below the pole top and on the same side of pole as hand hole, unless specified otherwise. 4. Outlet is located 4' above base and on same side of pole as hand hole, unless specified otherwise. Receptacle not included, provision only. 5. Additional hand hole is located 12" below pole top and 90° from standard hand hole location, unless otherwise specified.

### ANCHORAGE DATA

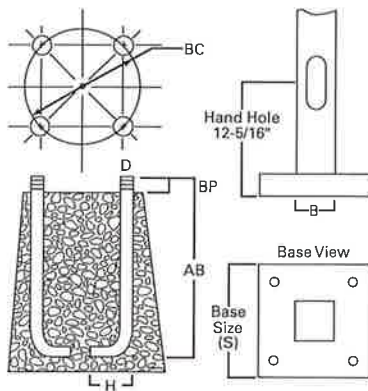

See technical information.

Pole	Template Number	Bolt Number	Bolt Circle (inches)	Number of Bolts	Bolt Size (inches)
SSS4	TMP1	AB1	8.5 - 11.0	4	3/4 x 25 x 3
SSS5	TMP1	AB1	11.0	4	3/4 x 25 x 3
SSS6	TMP2	AB3	12.5	4	1 x 36 x 4

**RECEIVED**  
**AUG 17 2020**  
**CLEARCREEK TOWNSHIP ZONING DEPT.**

Effective Projected Area (At Pole Top)

Mounting Height (Feet)	Catalog Number <sup>1,2</sup>	Wall Thickness (Inches)	Base Square <sup>3</sup> (Inches)	Bolt Circle Diameter (Inches)	Anchor Bolt Projection <sup>3</sup> (Inches)	Shaft Size <sup>3</sup> (Inches)	Anchor Bolt Diameter x Length x Hook (Inches)	Net Weight (Pounds)	Maximum Effective Projected Area (Square Feet) <sup>4</sup>				Max. Fixture Load - Includes Bracket (Pounds)
									80 mph	90 mph	100 mph	110 mph	
MH			S	BC	BP	B	D x AB x H						
10	SSS4A10S	0.120	10-1/2	11	4-1/2	4	3/4 x 25 x 3	85	30.0	22.0	17.0	13.0	100
15	SSS4A15S	0.120	10-1/2	11	4-1/2	4	3/4 x 25 x 3	118	15.0	11.5	8.7	6.5	100
20	SSS4A20S	0.120	10-1/2	11	4-1/2	4	3/4 x 25 x 3	150	8.7	5.9	3.9	2.5	150
20	SSS5A20S	0.120	10-1/2	11	4-1/2	5	3/4 x 25 x 3	183	15.4	11.1	7.9	5.5	150
25	SSS4A25S	0.120	10-1/2	11	4-1/2	4	3/4 x 25 x 3	181	3.7	1.7	0.3	--	200
25	SSS5A25S	0.120	10-1/2	11	5	5	3/4 x 25 x 3	222	9.3	6.0	3.5	1.6	200
25	SSS6A25S	0.120	12-1/2	12-1/2	5	6	1 x 36 x 4	284	9.9	6.1	3.5	1.2	200
30	SSS5A30S	0.120	10-1/2	11	4-1/2	5	3/4 x 25 x 3	260	4.7	2.1	--	--	200
30	SSS5M30S	0.188	10-1/2	11	4-1/2	5	3/4 x 25 x 3	392	10.4	6.4	3.5	1.5	200
30	SSS6A30S	0.120	12-1/2	12-1/2	5	6	1 x 36 x 4	330	4.3	1.4	--	--	200
30	SSS6M30S	0.188	12-1/2	12-1/2	5	6	1 x 36 x 4	489	19.0	13.0	8.7	5.6	200
35	SSS5M35S	0.188	10-1/2	11	4-1/2	5	3/4 x 25 x 3	453	5.8	2.8	--	--	200
35	SSS6M35S	0.188	12-1/2	12-1/2	5	6	1 x 36 x 4	564	12.8	7.2	3.7	1.0	200
35	SSS6X35S	0.250	12-1/2	12-1/2	5	6	1 x 36 x 4	738	16.5	11.0	6.8	3.5	200
39	SSS6M39S	0.188	12-1/2	12-1/2	5	6	1 x 36 x 4	618	7.3	3.0	--	--	300
39	SSS6X39S	0.250	12-1/2	12-1/2	5	6	1 x 36 x 4	816	13.0	7.0	3.7	0.8	300

Effective Projected Area (Two Feet Above Pole Top)

Mounting Height (Feet)	Catalog Number <sup>1,2</sup>	Wall Thickness (Inches)	Base Square <sup>3</sup> (Inches)	Bolt Circle Diameter (Inches)	Anchor Bolt Projection <sup>3</sup> (Inches)	Shaft Size <sup>3</sup> (Inches)	Anchor Bolt Diameter x Length x Hook (Inches)	Net Weight (Pounds)	Maximum Effective Projected Area (Square Feet) <sup>4</sup>				Max. Fixture Load - Includes Bracket (Pounds)
									80 mph	90 mph	100 mph	110 mph	
MH			S	BC	BP	B	D x AB x H						
10	SSS4A10S	0.120	10-1/2	11	4-1/2	4	3/4 x 25 x 3	85	23.0	17.5	14.0	11.0	100
15	SSS4A15S	0.120	10-1/2	11	4-1/2	4	3/4 x 25 x 3	118	13.4	10.0	7.5	5.7	100
20	SSS4A20S	0.120	10-1/2	11	4-1/2	4	3/4 x 25 x 3	150	7.6	5.2	3.4	2.1	150
20	SSS5A20S	0.120	10-1/2	11	4-1/2	5	3/4 x 25 x 3	183	13.8	9.9	7.1	4.9	150
25	SSS4A25S	0.120	10-1/2	11	4-1/2	4	3/4 x 25 x 3	181	3.4	1.6	0.3	--	200
25	SSS5A25S	0.120	10-1/2	11	5	5	3/4 x 25 x 3	222	8.5	5.5	3.2	1.5	200
25	SSS6A25S	0.120	12-1/2	12-1/2	5	6	1 x 36 x 4	284	9.1	5.6	3.0	1.2	200
30	SSS5A30S	0.120	10-1/2	11	4-1/2	5	3/4 x 25 x 3	260	1.8	--	--	--	200
30	SSS5M30S	0.188	10-1/2	11	4-1/2	5	3/4 x 25 x 3	392	9.6	5.9	1.9	0.2	200
30	SSS6A30S	0.120	12-1/2	12-1/2	5	6	1 x 36 x 4	330	4.1	1.3	--	--	200
30	SSS6M30S	0.188	12-1/2	12-1/2	5	6	1 x 36 x 4	489	18.5	12.5	8.4	5.3	200
35	SSS5M35S	0.188	10-1/2	11	4-1/2	5	3/4 x 25 x 3	453	5.5	2.4	--	--	200
35	SSS6M35S	0.188	12-1/2	12-1/2	5	6	1 x 36 x 4	564	11.8	7.0	3.5	1.0	200
35	SSS6X35S	0.250	12-1/2	12-1/2	5	6	1 x 36 x 4	738	16.0	10.5	6.4	3.4	200
39	SSS6M39S	0.188	12-1/2	12-1/2	5	6	1 x 36 x 4	618	7.0	2.4	--	--	300
39	SSS6X39S	0.250	12-1/2	12-1/2	5	6	1 x 36 x 4	816	12.0	6.7	3.0	0.5	300

NOTES:

1. Catalog number includes pole with hardware kit. Anchor bolts not included. Before installing, make sure proper anchor bolts and templates are obtained.
2. Tenon size or machining for rectangular arms must be specified. Hand hole position relative to drill location.
3. Shaft size, base square, anchor bolts and projections may vary slightly. All dimensions nominal.
4. EPAs based on shaft properties with wind normal to flat. EPAs calculated using base wind velocity as indicated plus 30% gust factor.

**RECEIVED**  
**AUG 17 2020**  
**CLEARCREEK TOWNSHIP**  
**ZONING DEPT.**





12, 18 and 26 Watt SLIM wall packs are ultra efficient and deliver impressive light distribution with a compact low-profile design that's super easy to install as a downlight or uplight.

Color: Bronze

Weight: 4.5 lbs

**Project:**

CLEARCREEK STOP

**Type:**

A

**Prepared By:**

**Date:**

7-28-20

**Driver Info**

Type	Constant Current
120V	0.18A
208V	0.09A
240V	0.09A
277V	0.08A
Input Watts	21.3W

**LED Info**

Watts	18W
Color Temp	3000K (Warm)
Color Accuracy	71 CRI
L70 Lifespan	100,000
Lumens	2,552
Efficacy	119.8 lm/W

## Technical Specifications

### Listings

**UL Listed:**

Suitable for wet locations. Suitable for mounting within 1.2m (4ft) of the ground.

**ADA Compliant:**

SLIM™ is ADA Compliant

**IESNA LM-79 & LM-80 Testing:**

RAB LED luminaires and LED components have been tested by an independent laboratory in accordance with IESNA LM-79 and LM-80.

**DLC Listed:**

This product is listed by Design Lights Consortium (DLC) as an ultra-efficient premium product that qualifies for the highest tier of rebates from DLC Member Utilities. DLC Product Code: PAYHGJ3C

### Construction

**IP Rating:**

Ingress Protection rating of IP66 for dust and water

**Cold Weather Starting:**

Minimum starting temperature is -40°C (-40°F)

**Maximum Ambient Temperature:**

Suitable for use in 40°C (104°F)

**Housing:**

Precision die-cast aluminum housing

**Mounting:**

Heavy-duty mounting bracket with hinged housing for easy installation

**Recommended Mounting Height:**

Up to 14 ft

**Lens:**

Tempered glass lens

**Reflector:**

Specular thermoplastic

**Gaskets:**

High-temperature silicone

**Finish:**

Formulated for high durability and long-lasting color

RECEIVED

AUG 17 2020

CLEARCREEK TOWNSHIP  
ZONING DEPT.

## Technical Specifications (continued)

### Construction

#### Green Technology:

Mercury and UV free. RoHS-compliant components.

### LED Characteristics

#### LED:

Multi-chip, long-life LED

#### Lifespan:

100,000-hour LED lifespan based on IES LM-80 results and TM-21 calculations

#### Color Consistency:

3-step MacAdam Ellipse binning to achieve consistent fixture-to-fixture color

#### Color Stability:

LED color temperature is warranted to shift no more than 200K in color temperature over a 5-year period

### Color Uniformity:

RAB's range of Correlated Color Temperature follows the guidelines for the American National Standard for Specifications for the Chromaticity of Solid State Lighting (SSL) Products, ANSI C78.377-2017.

### Other

#### Equivalency:

Equivalent to 100W Metal Halide

#### Patents:

The design of the SLIM™ is protected by patents in U.S. Pat D681,864, and pending patents in Canada, China, Taiwan and Mexico.

#### HID Replacement Range:

Replaces 100W Metal Halide

#### Warranty:

RAB warrants that our LED products will be free from defects in materials and workmanship for a period of five (5) years from the date of delivery to the end user, including coverage of light output, color stability, driver performance and fixture finish. RAB's warranty is subject to all terms and conditions found at [rablighting.com/warranty](http://rablighting.com/warranty).

### Buy American Act Compliance:

RAB values USA manufacturing! Upon request, RAB may be able to manufacture this product to be compliant with the Buy American Act (BAA). Please contact customer service to request a quote for the product to be made BAA compliant.

### Optical

#### BUG Rating:

B1 U1 G0

### Electrical

#### Driver:

Constant Current, Class 2, 100-277V, 50/60 Hz., 4KV surge protection, 120V: 0.19A, 208V: 0.11A, 240V: 0.10A, 277V: 0.08A

#### THD:

11% at 120V, 21% at 277V

#### Power Factor:

99.2% at 120V, 91.5% at 277V

## Dimensions

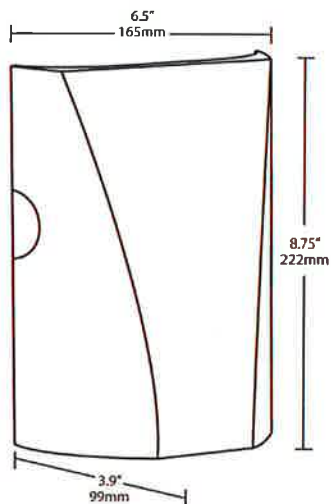

## Features

- Full cutoff, fully shielded LED wall pack
- Can be used as a downlight or uplight
- Contractor friendly features for easy installation
- 100,000-hour LED Life
- 5-Year, No-Compromise Warranty

RECEIVED

AUG 17 2020

CLEARCREEK TOWNSHIP  
ZONING DEPT.

## Ordering Matrix

Family	Wattage	Color Temp	Finish	Driver	Options
SLIM	18	Y			
12 = 12W	Blank = 5000K (Cool)	Blank = Bronze	Blank = Standard (120-277V)	Blank = No Option	
18 = 18W	N = 4000K (Neutral)	W = White	/D10 = Dimmable	/PC = 120V Button	
26 = 26W	Y = 3000K (Warm)			/PC2 = 277V Button	
				/LC = Lightcloud® Controller	

**RECEIVED**  
 AUG 11 / 2020  
 CLEARCREEK TOWNSHIP  
 ZONING DEPT.